

KC65GX-2P

High efficiency multicrystal photovoltaic module



EXAMPLES OF APPLICATION

- Stand-alone systems (electrifying remote houses, holiday homes and allotment systems, etc.)
- Supplying electricity to outlying villages and medical institutions in rural areas and development zones
- Emergency power supply, protection against catastrophes
- Pumping systems (drinking water supply and irrigation)
- Telecommunications (mobile phone networks, booster stations, etc.)
- Oil & gas (corrosion proofing, control, monitoring, etc.)



CUTTING-EDGE TECHNOLOGY

Exhaustive research work, continuous further development of production processes and highly automated production enable polycrystalline Kyocera solar modules to attain an exceptional standard of quality and markedly high levels of efficiency.

The integrated Kyocera high-performance solar cells with a standard size of 15 cm x 15.5 cm achieve over 16 % efficiency, guaranteeing an extremely high annual yield of energy from the photovoltaic system.

To protect against the harshest weather conditions, the cells are embedded between a reinforced glass covering (hailstorm resistance complying with IEC 61215 ed. 2, tested by TÜV) and EVA foil, and are sealed with a PET foil backing. The laminate is set in a sturdy aluminum frame which is easy to assemble.

The junction box on the module backside is equipped with bypass diodes that eliminate the risk of the individual solar cells overheating (hot spot effect). Photovoltaic modules can be easily wired using pre-assembled solar cables and multi-contact plugs.

Kyocera manufactures all the components at its own production sites – without buying in semi-finished products – to ensure consistently high product quality.

TUVdotCOM Service: Internet platform for tested quality and service
 TUVdotCom-ID: 0000022553
 IEC 61215 ed. 2, IEC 61730 and Safety Class II
 Kyocera is ISO 9001 and ISO 14001 certified and registered.



**KYOCERA
SOLAR**

We care!

SPECIFICATIONS

in mm

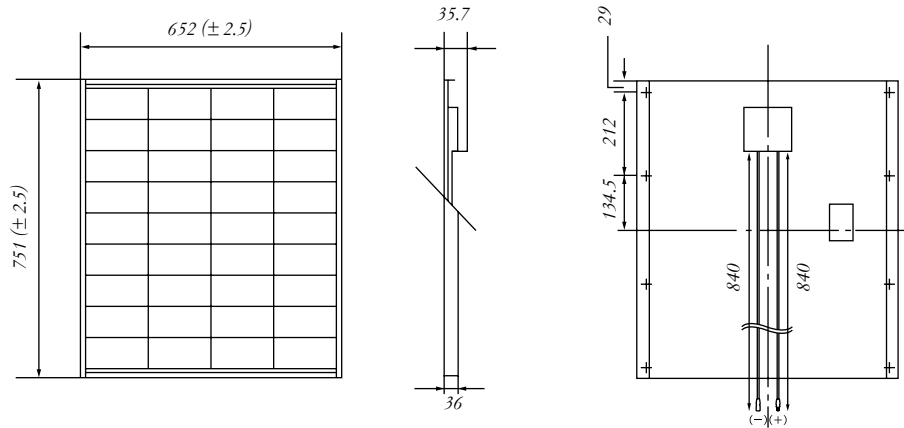

ELECTRICAL CHARACTERISTICS

Current-Voltage characteristics at various cell temperatures

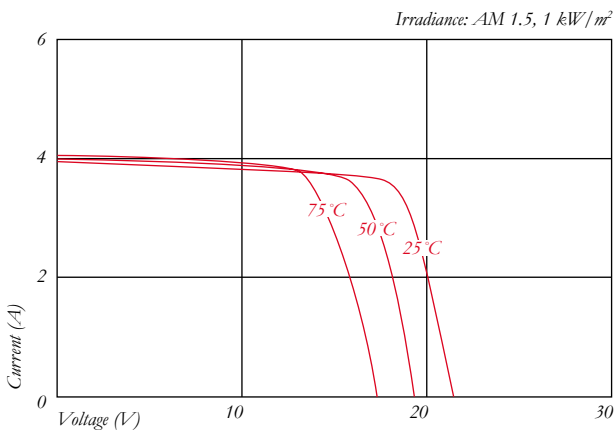

Current-Voltage characteristics at various irradiance levels

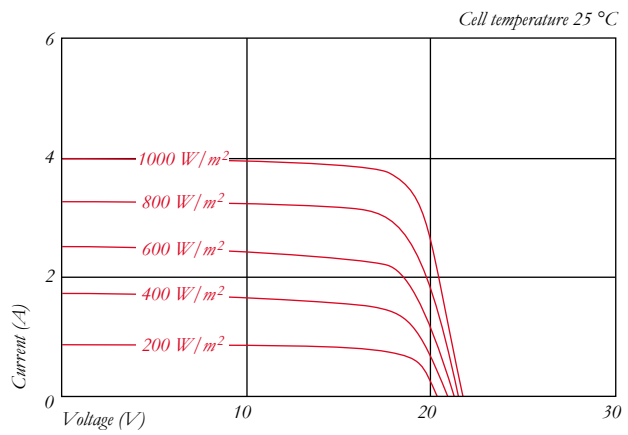

ELECTRICAL PERFORMANCE

PV Module Type	KC65GX-2P	
At 1000 W/m² (STC)*		
Maximum Power	[W]	65
Maximum System Voltage	[V]	750
Maximum Power Voltage	[V]	17.4
Maximum Power Current	[A]	3.75
Open Circuit Voltage (V _{OC})	[V]	21.7
Short Circuit Current (I _{SC})	[A]	3.99
At 800 W/m² (NOCT)**		
Maximum Power	[W]	46
Maximum Power Voltage	[V]	15.3
Maximum Power Current	[A]	3.01
Open Circuit Voltage (V _{OC})	[V]	19.7
Short Circuit Current (I _{SC})	[A]	3.22
NOCT	[°C]	47
Power Tolerance	[%]	+10 / -5
Maximum Reverse Current I _R	[A]	15
Series Fuse Rating	[A]	15
Temperature Coefficient of V _{OC}	[V/°C]	-8.21x10 ⁻²
Temperature Coefficient of I _{SC}	[A/°C]	1.59x10 ⁻³
Temperature Coefficient of Max. Power	[W/°C]	-3.24x10 ⁻¹
Reduction of Efficiency (from 1000 W/m ² to 200 W/m ²)	[%]	6.1

DIMENSIONS

Length	[mm]	751 (±2.5)
Width	[mm]	652 (±2.5)
Depth / incl. Junction Box	[mm]	36 / 36
Weight	[kg]	6.0
Cable	[mm]	(+)840 / (-)840
Connection Type	MC PV-KBT3 / MC PV-KST3	
Junction Box	[mm]	100x108x15
IP Code	IP65	

GENERAL INFORMATION

Performance Guarantee	10*** / 20 years****
Warranty	2 years

CELLS

Number per Module	36
Cell Technology	multicrystal
Cell Shape	rectangular
Cell Bonding	3 busbar

* Electrical values under standard test conditions (STC): irradiation of 1000 W/m², airmass AM 1.5 and cell temperature of 25 °C

** Electrical values under normal operating cell temperature (NOCT): irradiation of 800 W/m², airmass AM 1.5, wind speed of 1 m/s and ambient temperature of 20 °C

*** 10 years on 90% of the minimally specified power P under standard test conditions (STC)

**** 20 years on 80% of the minimally specified power P under standard test conditions (STC)

Your local Kyocera dealer:

**KYOCERA
SOLAR**

We care!

**KYOCERA Fin ceramics GmbH
Solar Division**
Fritz-Mueller-Str. 107
73730 Esslingen/Germany
Tel: +49 (0)711-93 93 49 99
Fax: +49 (0)711-93 93 49 50
Email: solar@kyocera.de
www.kyocerasolar.de